









## Emaux E-Power

-  Asynchronous. Two poles
-  IPX5 Waterproof standard
-  Built-in thermal protection
-  Overload protection
-  316 Stainless steel shaft
-  316 Stainless steel mechanical seal



## The Largest Single Phase Pump

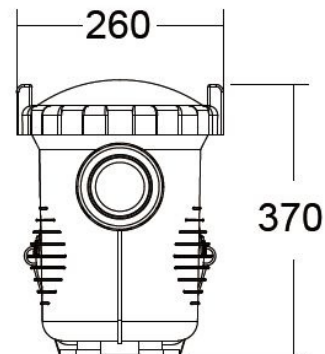
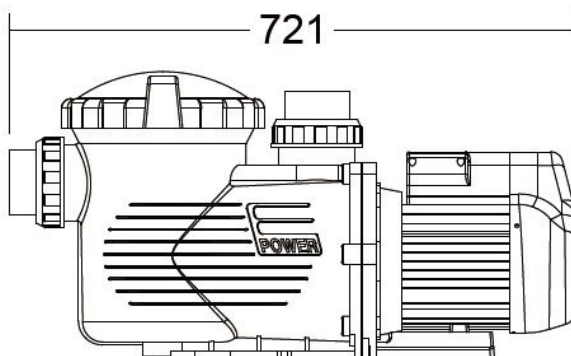
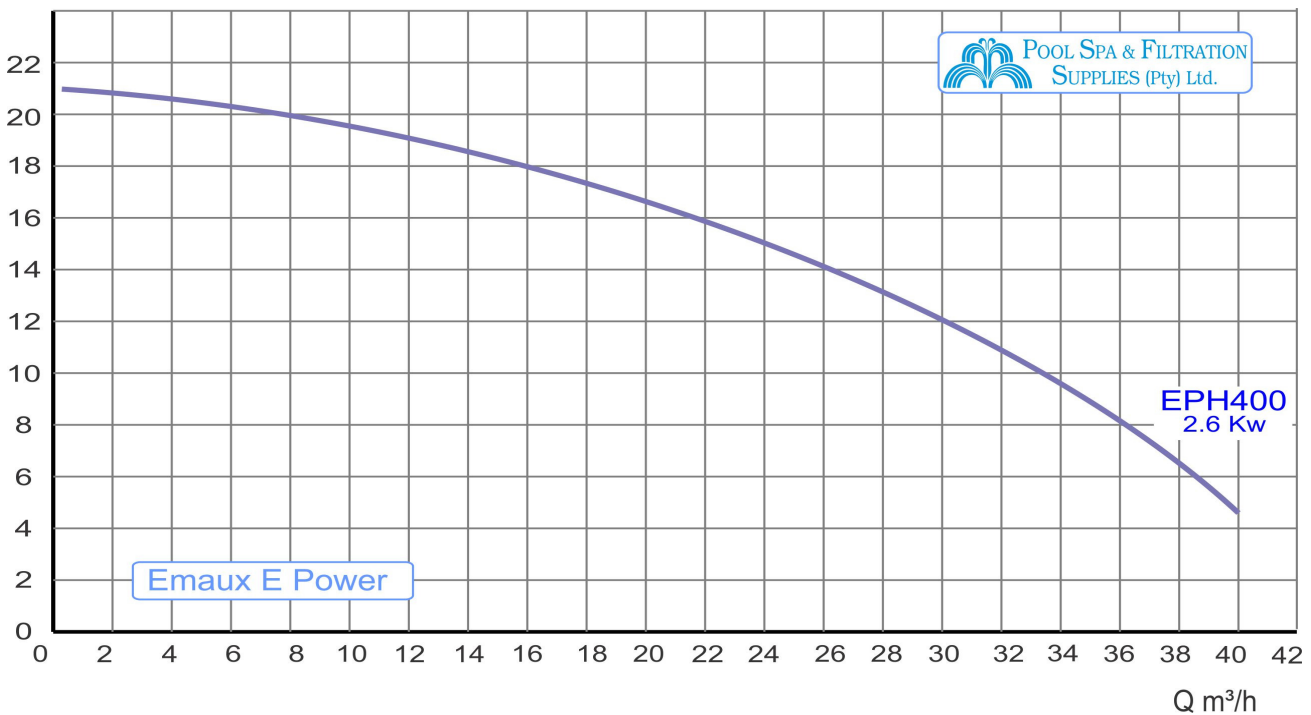

Code	Description	Max Head	Max Flow	Input power	Connection size	Weight
PEEPH4	E-Power 400	21m	40m³/h	2.6kw	75mm	25kg